

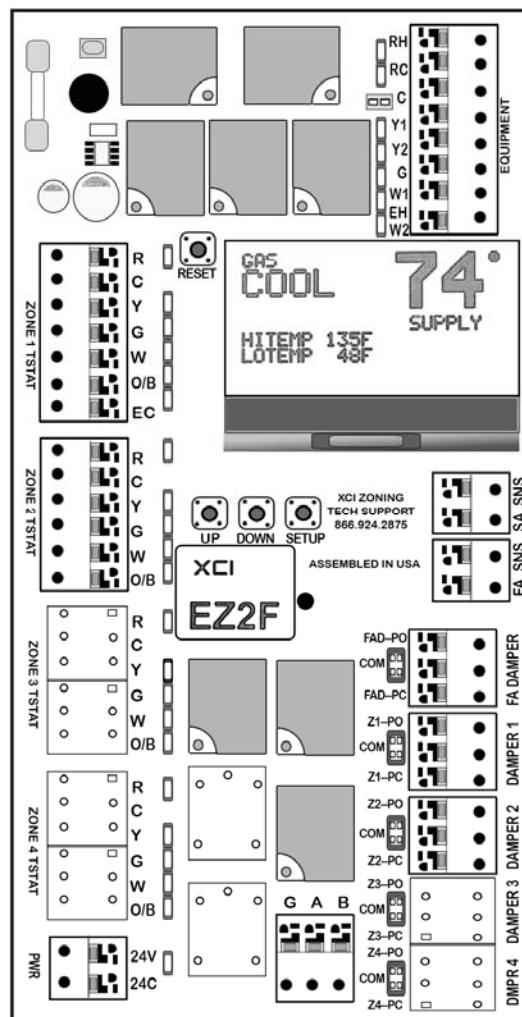

# EZ2F 2-Zone Controller



**READ THIS GUIDE BEFORE INSTALLING CONTROLLER**

## Zone Controller Installation and Start Up Guide v17e

**Input Ratings:**

Voltage: 18-40 VAC 50/60 HZ transformer of 40 VA or more

**Current Draw:**

Zone Controller: 10 VA

PO/PC Dampers: 3 VA

PC/SR Dampers: 8VA

PO/SR Dampers: 8 VA

All VA specifications at 24 VAC

**Fuse:**

5 x 20mm 30 ma Slo-Blo

**Temperature Ratings:**

Shipping: -20° to 150° F

Operating: -20° to 165° F

**Humidity Ratings:**

5% to 95% RH non-condensing

**Wiring:**

18-gauge SOLID wire

**CONFIGURATION OPTIONS**

Option #01	Set board function - Main or Expansion
Option #02	Set expansion address
Option #03	Set system type
Option #04	Set temperature display (Fahrenheit or Celcius)
Option #05	Set equipment stage (two-stage system ONLY)
Option #06	Set thermostat type (heat pump system ONLY)
Option #07	Set reversing valve actuation
Option #08	NOT USED/FOR FUTURE USE
Option #09	Set gas high temp cutout (gas and electric furnace ONLY)
Option #10	Set low temp cutout
Option #11	Set heat pump high temp cutout (heat pump system ONLY)
Option #12	Set aux. heat cut-in temp (single-stage heat pump ONLY)
Option #13	Set aux. heat cut-in time (single-stage heat pump ONLY)
Option #14	Set economizer mode - on or off
Option #15	Set economizer temperature set point (ONLY if economizer turned ON)
Option #16	Set fresh air minutes per hour (ONLY if economizer turned OFF)
Option #17	Set fresh air sensor mode - on or off (ONLY if fresh air minutes are greater than ZERO)
Option #18	Set fresh air low-temp lockout (ONLY if fresh air sensor mode is ON)
Option #19	Set fresh air high-temp lockout (ONLY if fresh air sensor mode is ON)
Option #20	Set dual fuel heat pump outdoor low-temp lockout (dual fuel system ONLY)
Option #21	Set second stage lockout - on or off (two-stage equipment ONLY)
Option #22	Set zone 1 priority
Option #23	Set auto changeover time - 10 or 15 minutes
Option #24	Disable aux. heat staging above 40 degrees outside air (heat pump systems ONLY)
Option #25	Allow zone 1 thermostat staging (two-stage systems ONLY)
Option #26	Set 2nd stage cut-in time based on time only ( OFF or ON)
Option #27	Set 2nd stage cut-in based on time and temperature
Option #28	Set 2nd stage cut-in time (time only)

## MOUNTING

Mount the EZ2F controller near the HVAC equipment. It can be mounted on a wall, stud, roof tress or the supply duct-work. It can be mounted in any orientation, including flat on top of the supply plenum. When mounting in a vertical position it should be leveled for a good appearance.

1. Remove the clear lid from the enclosure.
2. Place the controller in the desired position and use the base as a template to mark the hole locations.
3. Attach the controller to the surface with the appropriate screws (not included). If attaching the controller to drywall or ductboard, use hollow wall anchors to secure in place.

## POWER

The zoning system **REQUIRES A SEPARATE 24 VAC TRANSFORMER** (not included) for powering the controller, zone thermostats and dampers. It is recommended to install a fuse on the 24 VAC output from the transformer.

**DO NOT ATTEMPT TO POWER THE CONTROLLER FROM THE TRANSFORMER IN THE INDOOR UNIT!**

## TRANSFORMER SIZING

The 24 volt transformer must be sized and fused based on the controller, the total dampers and the thermostats.

XCI Device	Power
EZ2F Controller	10 VA
Power Open/Power Close Damper	3 VA
Spring Return Damper	8 VA
Typical Thermostat	2 VA

**EXAMPLE:** Transformer Calculation:  
 1 EZ2F (10 VA)  
 + 2 POC Dampers (3 VA X 2)  
 + 2 Thermostats (2 VA X 2)  
 = 20 VA Total

### FUSE SIZING RULE OF THUMB

Transformer VA	Fuse Size
40	2 amp
75	3 amp
100	4 amp



**CAUTION: Voltage Hazard.** Can cause electrical shock or equipment damage. Disconnect power before beginning installation. Wire entire zone panel before applying transformer power.

Connect the transformer to the 24V and 24C inputs on the zone control board.

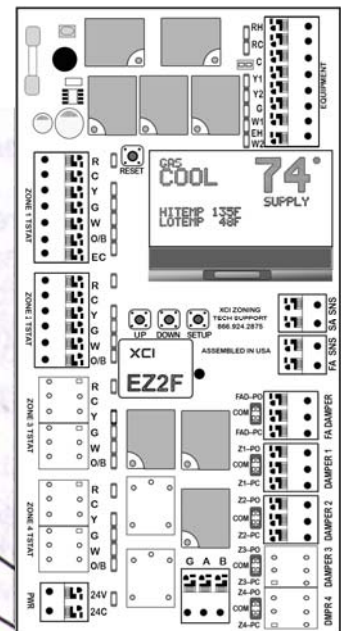
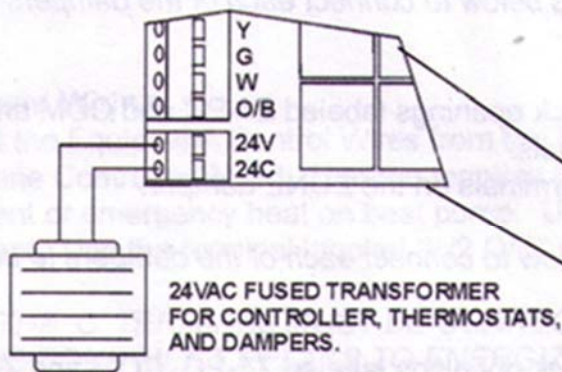

## Wiring

### Install thermostats using instructions provided with thermostats.

The EZ2F controller is compatible with most thermostats that have a common connection or are battery operated. The controller will use time and supply air temperature to automatically manage staging. This eliminates the need for multi-stage thermostats.

On *HEAT PUMP* equipment ONLY, either Gas/Electric or Heat Pump thermostats can be used. It is recommended to use a Heat Pump thermostat with an Emergency Heat switch on Zone 1 for all heat pump installations. An emergency heat call can ONLY be initiated from the ZONE 1 THERMOSTAT.

1. Connect either single stage gas/electric or heat pump thermostats to each terminal blocks labeled **Zone 1 TSTAT** and **Zone 2 TSTAT**.
2. The Zone 1 TSTAT will operate Damper 1. The Zone 2 TSTAT will operate Damper 2.
3. Using 18 Gauge Solid Thermostat Wire, strip 1/2 inch of insulation from each wire. Hold down the orange button and push the thermostat wire into the SCREWLESS terminals on the control board.
4. Connect the other end of the thermostat wire to the corresponding terminals on the thermostat.
5. To use the **EC** terminal on the Zone 1 TSTAT, a separate switch must be used to supply 24 VAC to this terminal. You may also use a 2-stage thermostat on Zone 1 **ONLY** if you want to control Zone 1 staging by connecting Y2 from the thermostat to the **EC** terminal on the Zone 1 terminal block. ( See Option #25)

### HEAT PUMP THERMOSTAT

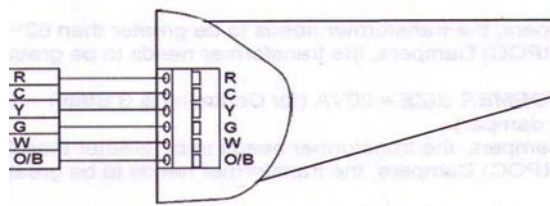

### GAS/ELECTRIC THERMOSTAT

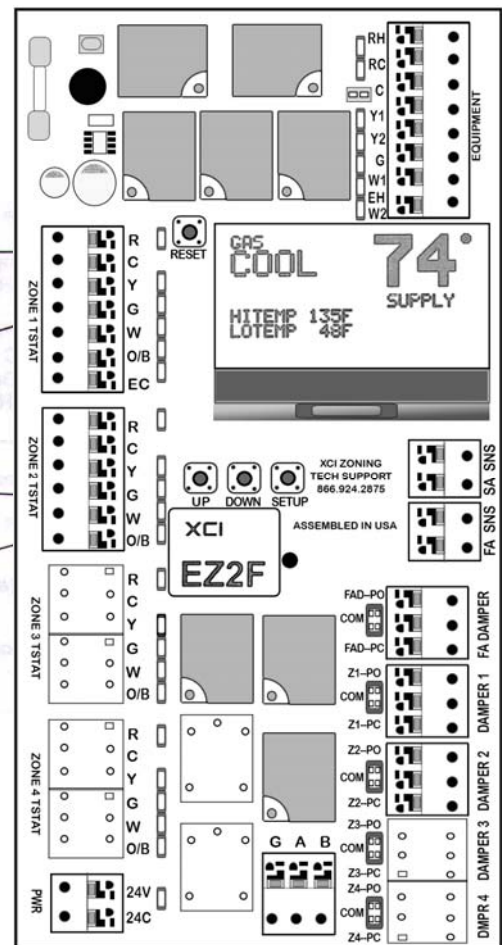
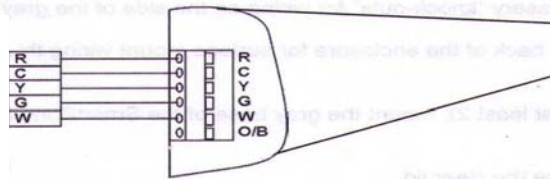

## Wiring

The EZ2F will operate either 2-Wire Power Close/Spring Open dampers, or 3-Wire Power Open/Power Close dampers.

### Power Close/Spring Open 2-Wire Dampers

1. Use 18/2 or 18/3 solid core wire.
2. Strip 1/2 inch of insulation from each wire.
3. Hold down the orange button on the Damper 1 terminal block labeled **Z1-PC** and **COM** and push the two wires for the zone damper into the SCREWLESS terminals.
4. Connect the other end of the wires to the SCREWLESS terminals on the zone damper.
5. Repeat steps 3 and 4 for the Zone 2 damper.

### Power Open/Power Close 3-Wire Dampers

1. Use 18/3 solid core wire
2. Strip 1/2 inch of insulation from each wire.
3. Hold down the orange button on the Damper 1 terminal block and push the three wires for the zone damper into the SCREWLESS terminals. Use *WHITE* for Common (C), *GREEN* for Power Open (PO) and *RED* for Power Close (PC).
4. Connect the other end of the wires to the terminals on the zone damper, using the same color code.
5. Repeat steps 3 and 4 for the Zone 2 damper.

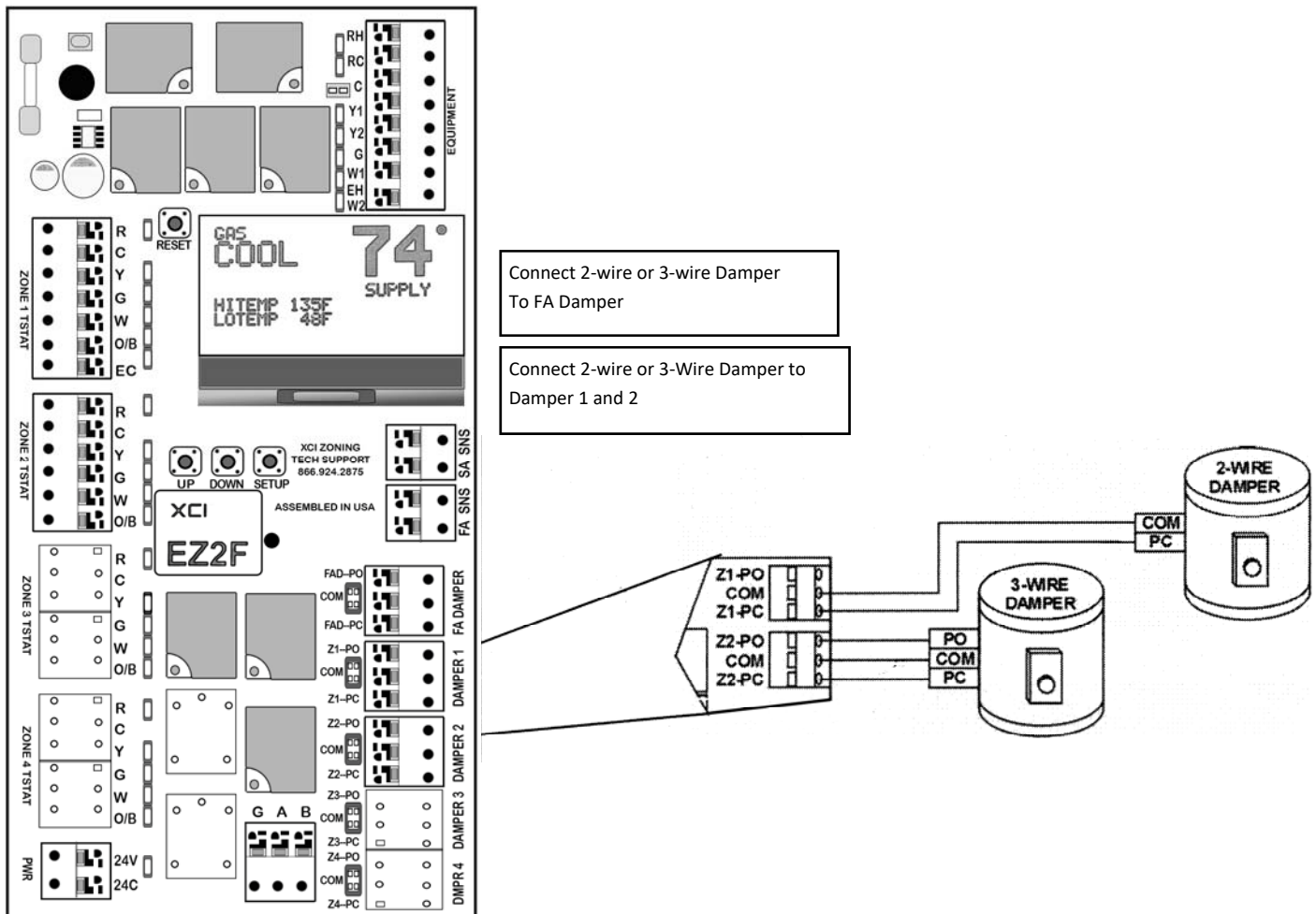

**Wiring**

**Supply Air Temperature Sensor (SAS)**

*Sensor Placement (Location)*

Gas/Electric - Electric/Electric - The SAS should be located in the Supply Air Plenum where it will sense AVERAGE air temperature within the Plenum. The ideal placement is 2 to 4 feet beyond the evaporator coil. Make sure the sensor is in the air stream and secured properly.

Heat Pump - The SAS should be located inside the air handler cabinet AFTER the evaporator coil but BEFORE the blower. Make sure the sensor is in the air stream and properly secured.

**Return Air Sensor (RAS)**

*Sensor Placement (Location)*

The RAS should be located in the return air plenum before the blower or evaporator coil section where it will sense the AVERAGE return air temperature entering the air handler or furnace. Make sure the sensor is in the air stream and properly secured.

**OPTIONAL Fresh Air/Outdoor Air Sensor (FAS)**

*Sensor Placement (Location)*

The OAS should be located under the eave of the structure or under a ledge on the outdoor unit where it will not be in direct sunlight. Secure the sensor in place and connect to the controller with thermostat wire and the included plug-in connector.

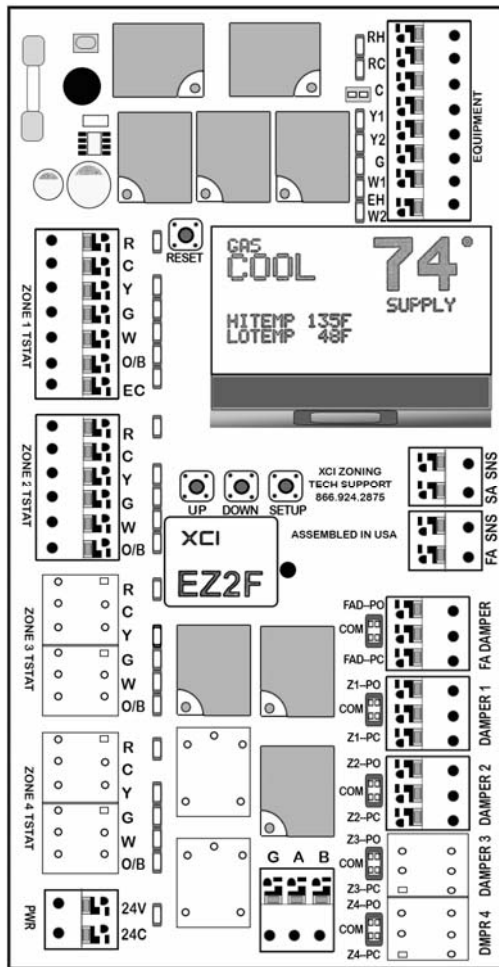

**IMPORTANT!! IF THE SUPPLY AIR SENSOR IS NOT PLUGGED INTO THE ZONE BOARD, THE BOARD WILL ONLY ACCEPT A CALL FROM THE ZONE 1 THERMOSTAT AND WILL HOLD ALL OF THE DAMPERS OPEN. This function allows the system to operate and condition all zones if the supply air sensor fails or becomes damaged.**

← **PLUG IN SUPPLY AIR SENSOR HERE**

← **PLUG IN FRESH AIR OR RETURN AIR SENSOR HERE**

**SmartLink Cable**

If using the EZ2F controller as an expansion module, or as the Master board in a multiple-board system use 18/3 thermostat wire. Strip back wire and connect each end to the 3-pole plug located at the bottom of the board. MAKE SURE THE SAME COLOR WIRE IS CONNECTED TO EACH POLE ON BOTH PLUGS. The system can be expanded to a total of 9 expansion and 1 master controller for a maximum of 40 zones.

↑ **PLUG IN SMARTLINK CABLE HERE IF USING AS AN EXPANSION BOARD**

## Wiring

### A/C - Gas Furnace and A/C - Electric Furnace

Using 18 gauge solid thermostat wire, connect the Equipment Control Wires from the Indoor Unit to the *EQUIPMENT* terminal block on the top right corner of the SmartZone Controller. Use the terminal labeled **W1/EH** for first stage heat. If using a two-stage furnace, connect **W2/OB** to **W2** on the indoor equipment. Connect **R** from the equipment to **RC** on the controller. Connect **C** from the equipment to **C** on the SmartZone Controller. **THE C TERMINAL FROM THE EQUIPMENT MUST BE CONNECTED TO THE CONTROLLER FROM THE EQUIPMENT FOR THE RC AND RH LED'S TO ILLUMINATE.** POWER FROM THE EQUIPMENT TRANSFORMER WILL ILLUMINATE THE **RC** AND **RH** TERMINAL LED'S, INDICATING THE EQUIPMENT TRANSFORMER IS CONNECTED.

**NOTE:** IF USING A TWO-TRANSFORMER SYSTEM, WITH SEPARATE COOLING AND HEATING TRANSFORMERS, CONNECT THE **R** FROM THE COOLING TRANSFORMER TO **RC** ON THE CONTROLLER. CONNECT THE **R** FROM THE HEATING TRANSFORMER TO **RH** ON THE CONTROLLERS. REMOVE THE BLACK JUMPER LOCATED JUST BELOW THE RC/RH LED'S TO SEPARATE THE POWER INPUTS.

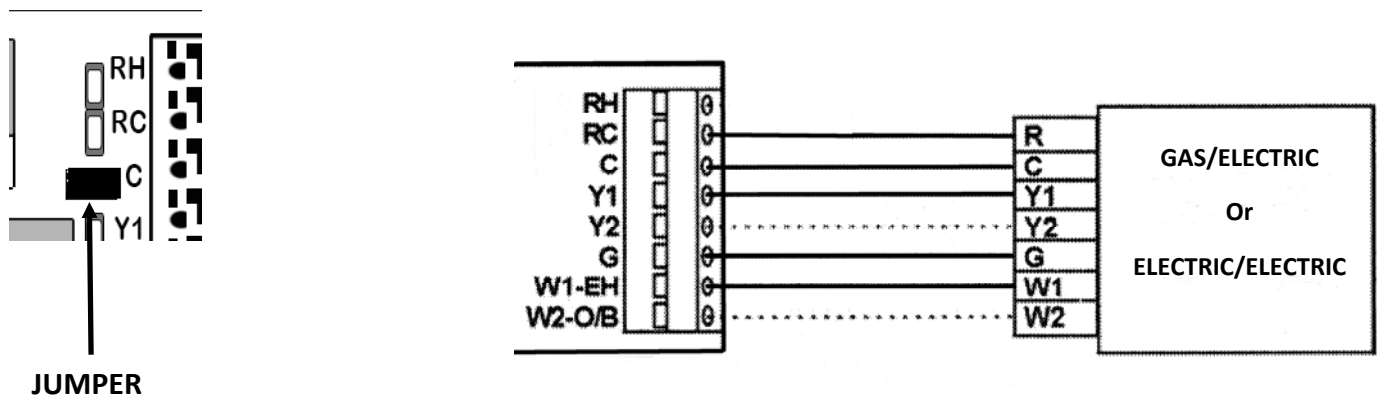

### Electric Heat Pump

Using 18 gauge solid thermostat wire, connect the Equipment Control Wires from the Indoor Unit to the *EQUIPMENT* terminal Block on the top right corner of the SmartZone Controller. Use the terminal labeled **W1/EH** for the auxiliary heat strips. Connect the **W2/OB** terminal to the **O/B** terminal on the equipment (REVERSING VALVE). Connect **R** from the equipment to **RC** on the SmartZone Controller. Connect **C** from the equipment to **C** on the TL-EZ4F Controller. **THE C TERMINAL FROM THE EQUIPMENT MUST BE CONNECTED TO THE CONTROLLER FROM THE EQUIPMENT FOR THE RC AND RH LED'S TO ILLUMINATE.** POWER FROM THE EQUIPMENT TRANSFORMER WILL ILLUMINATE THE **RC** AND **RH** TERMINAL LED'S, INDICATING THE EQUIPMENT TRANSFORMER IS CONNECTED AND WORKING.

**NOTE:** The jumper for **RH/RC** should **NOT** be removed on a heat pump system.

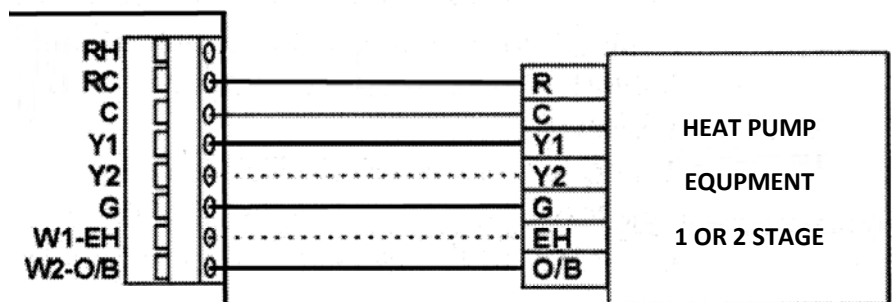



**BYPASS ELIMINATION ON SINGLE SPEED SYSTEMS:** When the board is set up for 1-speed outdoor unit, the board will energize Y-2 to the equipment if more than one zone is calling. This allows the use of a 2-speed or multi-speed indoor unit with a Y-1 and Y-2 terminal. The indoor fan speeds can be set up to run on a lower speed on Y-1, and a higher speed on Y-2; eliminating the need for a bypass damper.

When using the **EZ2F** or **EZ4F** as an expansion module you must connect 24 VAC input power to the expansion controller(s). Power IS NOT supplied by the communication cable. If using only one transformer to supply the master and expansion controllers, calculate the power needed for all boards, thermostats and damper actuators to determine the correct size. (See Page 2 in the Installation Guide) On larger installations, more than one transformer may be needed.

A communication cable must be installed via the 3-pole plug-in connector at the bottom of the board. Use standard 18-3 thermostat wire. NO CAT5 CABLE IS NEEDED. If installing more than one expansion module, daisy chain the wiring from each controller to the next. BE SURE AND CONNECT THE SAME COLOR WIRE IN EACH POSITION!

(Example - Red wire in all left positions, White wire in all center positions, Green wire in all right positions)

After all wiring is complete, turn on the 24 VAC input power to all of the controllers. On the slave controller, push the setup button. Change the board type to "EXPANSION". Press the setup button again to set the slave address. The default expansion address is 1. (If installing more than one expansion controller, each controller will need its own address. The second expansion controller will be address 2 and so on, up to 9 expansion controllers). Press the setup button and set the equipment type. (If setting up for electric heat pump or dual fuel, the menu will ask you to set the thermostat type for each zone). Press the setup button to exit the configuration menu. The display will show that the controller is an "EXPANSION" and will show "COMM" at the bottom of the display. If "NO COMM" is displayed, check communication wiring connections.

After the expansion controller(s) are configured, press the RESET button on all of the controllers. This will clear the communication bus and allow the expansion controllers to make equipment calls.

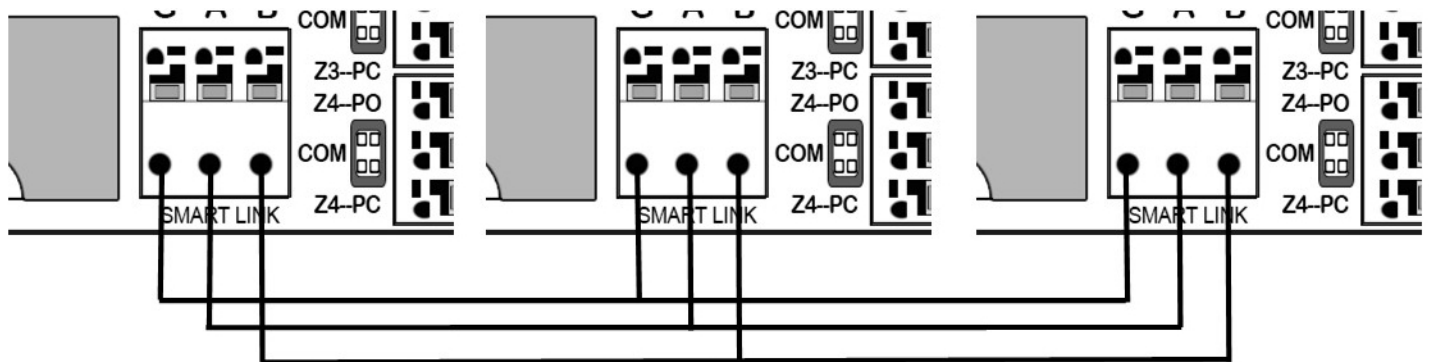

**CONNECT 24 VAC TO ALL CONTROLLERS**



## Configuration and Setup

The EZ2F Controller has a state of the art microprocessor for reliable control of the equipment and zone dampers. The simple step by step setup eliminates the need for confusing dip switches. The full status back-lit LCD display guides you thru each step of the setup process. Depending on the type of equipment selected, the display will show you each available option for the system type selected.

---

Make sure that all wiring for the thermostats, zone dampers and equipment is complete. The **RH** and **RC** led's should be illuminated. The connectors from the Supply Air Sensor (SAS) should be plugged firmly into the receptacle marked SA SNS on the controller. If using a Return Air Sensor (RAS) or Fresh Air Sensor (OAS) the connectors should be firmly plugged into the receptacle marked FA SNS on the controller. If using the controller as an expansion module, the wiring should be firmly plugged into the receptacle marked SMART LINK at the bottom of the controller. Apply power from the 24VAC transformer connected to the **PWR** connector on the controller. The controller will power up and display a splash screen on the LCD display. The red **R** led's for all thermostats and the green led's for all dampers will illuminate. The display will then show the factory default settings for the controller.

---

### IF YOU GO PAST THE DESIRED SETUP OPTION, PRESS THE RESET BUTTON TO START OVER.

Press the **SETUP** button to enter the configuration mode. The screen will display the **SETUP MENU** and **OPTION #01 - SET BOARD FUNCTION**. The factory default is **MAIN**. If using the controller as an expansion module, press the **UP** or **DOWN** button to change to **EXPANSION**. Press the **SETUP** button to proceed to the next option. (**NOTE:** If using the controller as an expansion module, the next selection will be **OPTION #02 - SET EXPANSION ADDRESS**. Each expansion board will have its own address, numbered 1 thru 9. The default address is 1. If using more than one expansion board, the second expansion board will be address 2 and so on, up to 9 expansion boards. Press the **SETUP** button to proceed to the next option.

---

### A/C - GAS HEAT AND A/C - ELECTRIC HEAT

**OPTION #03 - SET SYSTEM TYPE** The default setting is **A/C - GAS HEAT**. Use the up button to select **A/C - ELEC HEAT**. Press the **SETUP** button to proceed to the next option.

---

**OPTION #05 - SET OUTDOOR UNIT SPEED** The default setting is **1-SPEED**. Press the **UP** or **DOWN** button to change to **2-SPEED**. Press the **SETUP** button to proceed to the next option.

---

**OPTION #09 - SET HI-TEMP CUT-OUT** The default setting is **135° F (60° C)**. Press the **UP** or **DOWN** button to change the temperature. The adjustable range is **125° F to 150° F (57° to 65° C)**. Press the **SETUP** button to proceed to the next option.

**NOTE: When using electric furnace, the HI-TEMP CUT-OUT should be set no higher than 125° F (52° C).**

---

**OPTION #10 - SET LO-TEMP CUTOUT** The default setting is **44° F (7° C)**. Press the **UP** or **DOWN** button to change the temperature. The adjustable range is **40° F to 52° F (4° to 11° C)**. Press the **SETUP** button to proceed to the next option.

---

**OPTION #14 - SET ECONOMIZER MODE** The default setting is **OFF**. Press the **UP** or **DOWN** button to turn **ON**.

Press the **SETUP** button to proceed to the next option.

**NOTE: If economizer mode is OFF, the next option is OPTION #16.**

**If economizer mode is ON, the next option is OPTION #15.**

---

**OPTION #15 - SET ECONOMIZER OUTSIDE SETPOINT** - The default setting is **55° F (13° C)**. Press the **UP** or **DOWN** button to change the temperature. The adjustable range is **50° F to 75° F (10° C to 24° C)**.

Press the **SETUP** button to proceed to the next option.

---

## Configuration and Setup

### A/C - GAS HEAT AND A/C - ELECTRIC HEAT (CONTINUED)

**OPTION #16 - SET FRESH AIR MIN/HR** The factory default is **0** minutes. Press the **UP** button to add fresh air minutes. The adjustable range is **0** to **60** minutes per hour, adjustable in **5 minute** increments. **NOTE: THIS OPTION IS ONLY AVAILABLE IF OPTION #14 (ECONOMIZER) IS TURNED OFF.** Press the **SETUP** button to proceed to the next option.

**NOTE: If fresh air minutes are GREATER than ZERO (0) then the next option will be OPTION #17.**

**If fresh air minutes are set at ZERO (0), and the Equipment Stage is set for 1-Stage, then the next option will be OPTION #22. If the Equipment Stage is set for 2-Stage, the next option will be OPTION #21**

---

**OPTION #17 - SET FRESH AIR SENSOR MODE** The factory default is **OFF**. Press the **UP** or **DOWN** button to turn the sensor **ON**. (**NOTE: If there is no sensor detected plugged into the FA SNS receptacle on the controller, the controller will display **INSTALL FA SENSOR****). After the sensor is plugged in, press the **RESET** button to clear the error message. Press the **SETUP** button several times until **OPTION #17** appears on the display. Press the **SETUP** button to turn the sensor **ON**. Press the setup button to proceed to the next option.

**NOTE: If the fresh air sensor mode is set to ON, then the next option will be OPTION #18.**

**If the fresh air sensor mode is set to OFF, and the Equipment Stage is set for 1-Stage, then the next option will be OPTION #22.**

**If the Equipment Stage is set for 2-Stage, then the next option will be OPTION #21.**

---

**OPTION #18 - SET FRESH AIR LO-TEMP LOCKOUT** The factory default is **20° F (-6° C)**. Press the **UP** or **DOWN** button to change the temperature. The adjustable range is **20° F to 40° F (-6° F to 4° C)**. Press the **SETUP** button to proceed to the next option.

---

**OPTION #19 - SET FRESH AIR HI-TEMP LOCKOUT** The factory default is **80° F (26° C)**. Press the **UP** or **DOWN** button to change the temperature. The adjustable range is **60° to 100° F (15° to 37° C)**. Press the **SETUP** button to proceed to the next option.

**NOTE: If the Equipment Stage is set for 1-Stage, the next option will be OPTION #22.**

**If the Equipment Stage is set for 2-Stage, the next option will be OPTION #21.**

---

**OPTION #21 - SET SECOND STAGE LOCKOUT** The factory default is **OFF**. Press the **UP** or **DOWN** button to turn **ON**. When this option is turned **ON**, the controller **WILL NOT ENERGIZE 2ND STAGE** if only **ONE ZONE** is calling. Press the **SETUP** button to proceed to the next option.

---

**OPTION #22 - SET ZONE 1 PRIORITY** The factory default is **OFF**. Press the **UP** or **DOWN** button to turn **ON**. When this option is turned on, any call from the **ZONE 1 THERMOSTAT** will override any call from the **ZONE 2, 3 or 4 THERMOSTAT**. If a call exists on any thermostat other than the **ZONE 1 THERMOSTAT**, and an opposing call is made from the **ZONE 1 THERMOSTAT**, the system will immediately to into a **3-minute PURGE** and then will turn on the equipment based on the call from the **ZONE 1 THERMOSTAT**. Press the **SETUP** button to proceed to the next option.

---

**OPTION #23 - SET AUTO CHANGEOVER TIME** The factory default is **10 minutes**. Press the up or down button to change the setting to **15 MINUTES**. This setting determines the amount of time that elapses after an opposing call occurs and the system changes over to the opposing call. Press the **SETUP** button to proceed.

**NOTE: If the equipment stage is set for 1-STAGE, pressing the SETUP button will exit the configuration mode.**

**If the equipment stage is set for 2-STAGE then the setup will proceed to OPTION #25.**

---

**OPTION #25 - ALLOW ZONE 1 THERMOSTAT STAGING** The default setting is **OFF**. Press the **UP** or **DOWN** button to turn **ON**. When this setting is **ON**, the controller will accept a 2nd stage call from the Zone 1 Thermostat. **NOTE: When this option is turned ON, Zone 1 will DISREGARD 2ND STAGE LOCKOUT if Option #21 is turned ON.**

**NOTE: This option will only be available if Option #05 is set for 2-STAGE.**

Press the **SETUP** button to proceed to the next option.

## Configuration and Setup

### A/C - GAS HEAT AND A/C - ELECTRIC HEAT (CONTINUED)

**OPTION #26 - SET 2ND STAGE CUT-IN TIME BASED ON TIME ONLY** The default setting is **OFF**. Press the **UP** or **DOWN** button to turn to **ON**. Press the **SETUP** button to proceed to the next option

---

**OPTION #27 - SET 2ND STAGE CUT-IN BASED ON TIME AND TEMPERATURE** (THIS OPTION ONLY APPEARS IF OPTION #26 IS TURNED OFF). The default setting is **8 MINS**. Press the **DOWN** button to change the setting to **6 MINS** or **4 MINS**. Press the **SETUP** button to proceed to the next option.

---

**OPTION #28 - SET 2ND STAGE CUT-IN TIME (TIME ONLY)** (THIS OPTION ONLY APPEARS IF OPTION #26 IS TURNED ON) The default setting is **15 MINS**. Press the **UP** or **DOWN** button to change to **10 MINS** or **20 MINS**. Press the **SETUP** button to exit the setup menu.

---

### ELECTRIC HEAT PUMP - ELECTRIC AUXILIARY HEAT

Press the **SETUP** button to enter the configuration mode. The screen will display the **SETUP MENU AND OPTION #03 - SET SYSTEM TYPE**. The default setting is **A/C - GAS ELECTRIC**. Press the **UP** button twice to change the system to **ELECTRIC HEAT PUMP**. Press the **SETUP** button to proceed to the next option.

---

**OPTION #04 - SET TEMPERATURE DISPLAY** The default setting is **FAHRENHEIT**. Press the **UP** or **DOWN** button to change the setting to **CELCIUS**. Press the **SETUP** button to proceed to the next option.

---

**OPTION #05 - SET OUTDOOR UNIT SPEED** The default setting is **1-SPEED**. If using single stage equipment, press the **SETUP** button to proceed to the next option. If using 2-stage equipment, press the **UP** or **DOWN** button to select **2-SPEED**. Press the **SETUP** button to proceed to the next option.

---

**OPTION #06 - SET THERMOSTAT 1 TYPE** The default setting is **GAS/ELECTRIC**. Press the **UP** or **DOWN** button to change to **HEAT PUMP**. Press the **SETUP** button to **SET THERMOSTAT 2 TYPE**. Repeat for the **Zone 3** and **Zone 4** Thermostats The default setting is **GAS/ELECTRIC**. Press the **UP** or **DOWN** button to change to **HEAT PUMP**.

**NOTE: A heat pump thermostat with an emergency heat switch MUST be installed on Zone 1 to manually turn on auxiliary heat.** Press the **SETUP** button to proceed to the next option.

---

**OPTION #07 - SET REVERSING VALVE ACTUATION** The default setting is **REV-O**. Press the **UP** or **DOWN** button to change to **REV-B**. **NOTE:** When set as **REV-O**, the reversing valve will energize in COOLING. When set as **REV-B**, the reversing valve will energize in HEATING. Press the **SETUP** button to proceed to the next option.

---

**OPTION #10 - SET LO-TEMP CUTOUT** The default setting is **44° F (7° C)**. Press the **UP** or **DOWN** button to change the temperature. The adjustable range is **40 F to 52 F**. Press the **SETUP** button to proceed to the next option.

---

**OPTION #11 - SET HEAT PUMP HI-TEMP CUTOUT** The default setting is **120° F (48° C)**. Press the **UP** or **DOWN** button to change the setting. The adjustable range is **110° F - 125° F (43° - 52° C)**. Press the **SETUP** button to proceed to the next option.

**NOTE: If Option #05 is set for 1-STAGE, the next option will be OPTION #12.**

**If Option #05 is set for 2-STAGE, the next option will be OPTION #14.**

---

**OPTION #12 - SET AUX HEAT CUT-IN TEMP** The default is **90° F (32° C)**. Press the **UP** or **DOWN** button to change the setting. The adjustable range is **90° - 100° F (32° - 37° C)**. Press the **SETUP** button to proceed to the next option.

**NOTE: This option only available on 1-STAGE systems.**

---

**OPTION #13 - SET AUX HEAT CUTIN TIME** The default is **6 Mins**. Press the **UP** or **DOWN** button to change the setting. The adjustable range is **3 - 6 MINS**. Press the **SETUP** button to proceed to the next step.

**NOTE: This option only available on 1-STAGE systems.**

---

## Configuration and Setup

### ELECTRIC HEAT PUMP - ELECTRIC AUXILIARY HEAT (CONTINUED)

**OPTION #14 - SET ECONOMIZER MODE** The default setting is **OFF**. Press the **UP** or **DOWN** button to turn **ON**. Press the **SETUP** button to proceed to the next option.

**NOTE: If economizer mode is OFF, the next option is OPTION #16.**  
**If economizer mode is ON, the next option is OPTION #15.**

---

**OPTION #15 - SET ECONOMIZER OUTSIDE SETPOINT** - The default setting is **55° F (12° C)**. Press the **UP** or **DOWN** button to change the temperature. The adjustable range is **50° F to 75° F (10° to 24° C)**. Press the **SETUP** button to proceed to the next option.

---

**OPTION #16 - SET FRESH AIR MIN/HR** The factory default is **0** minutes. Press the **UP** button to add fresh air minutes. The adjustable range is **0 to 60** minutes per hour, adjustable in **5 minute** increments. **NOTE: THIS OPTION IS ONLY AVAILABLE IF OPTION #14 (ECONOMIZER) IS TURNED OFF.** Press the **SETUP** button to proceed to the next option.

**NOTE: If fresh air minutes are GREATER than ZERO (0) then the next option will be OPTION #17.**  
**If fresh air minutes are set at ZERO (0), and the Equipment Stage is set for 1-Stage, then the next option will be OPTION #22.**  
**If the Equipment Stage is set for 2-Stage, the next option will be OPTION #21**

---

**OPTION #17 - SET FRESH AIR SENSOR MODE** The factory default is **OFF**. Press the **UP** or **DOWN** button to turn the sensor **ON**. (**NOTE: If there is no sensor detected plugged into the FA SNS receptacle on the controller, the controller will display INSTALL FA SENSOR**). After the sensor is plugged in, press the **RESET** button to clear the error message. Press the **SETUP** button several times until **OPTION #17** appears on the display. Press the **SETUP** button to turn the sensor **ON**. Press the setup button to proceed to the next option.

**NOTE: If the fresh air sensor mode is set to ON, then the next option will be OPTION #18.**  
**If the fresh air sensor mode is set to OFF, and the Equipment Stage is set for 1-Stage, then the next option will be OPTION #22.**  
**If the Equipment Stage is set for 2-Stage, then the next option will be OPTION #21.**

---

**OPTION #18 - SET FRESH AIR LO-TEMP LOCKOUT** The factory default is **20° F (-6° C)**. Press the **UP** or **DOWN** button to change the temperature. The adjustable range is **20° F to 40° F (-6° to 4° C)**. Press the **SETUP** button to proceed to the next option.

---

**OPTION #19 - SET FRESH AIR HI-TEMP LOCKOUT** The factory default is **80° F (26° C)**. Press the **UP** or **DOWN** button to change the temperature. The adjustable range is **60° to 100° F (15° to 37° C)**. Press the **SETUP** button to proceed to the next option.

**NOTE: If the Equipment Stage is set for 1-Stage, the next option will be OPTION #22.**  
**If the Equipment Stage is set for 2-Stage, the next option will be OPTION #21.**

---

**OPTION #21 - SET SECOND STAGE LOCKOUT** The factory default is **OFF**. Press the **UP** or **DOWN** button to turn **ON**. When this option is turned **ON**, the controller **WILL NOT ENERGIZE 2ND STAGE** if only **ONE ZONE** is calling. Press the **SETUP** button to proceed to the next option.

**NOTE: This option will only appear if Option #05 is set for 2-STAGE equipment.**

---

**OPTION #22 - SET ZONE 1 PRIORITY** The factory default is **OFF**. Press the **UP** or **DOWN** button to turn **ON**. When this option is turned on, any call from the **ZONE 1 THERMOSTAT** will override any call from the **ZONE 2, 3 or 4 THERMOSTAT**. If a call exists on any thermostat other than the **ZONE 1 THERMOSTAT**, and an opposing call is made from the **ZONE 1 THERMOSTAT**, the system will immediately to into a **3-minute PURGE** and then will turn on the equipment based on the call from the **ZONE 1 THERMOSTAT**.

---

## Configuration and Setup

### ELECTRIC HEAT PUMP - ELECTRIC AUXILIARY HEAT (CONTINUED)

**OPTION #23 - SET AUTO CHANGEOVER TIME** The factory default is **10 minutes**. Press the up or down button to change the setting to **15 MINUTES**. This setting determines the amount of time that elapses after an opposing call occurs and the system changes over to the opposing call. Press the **SETUP** button to proceed to the next option.

---

**OPTION #24 - DISABLE AUX HEAT STAGING ABOVE 40° F (4° C)** The default setting is **OFF**. Press the **UP** or **DOWN** button to turn **ON**. When this feature is turned **ON**, the controller WILL NOT stage on Auxiliary Heat if the **OUTDOOR TEMPERATURE** is above **40° F (4° C)**.

**NOTE: This option REQUIRES the use of a FRESH AIR SENSOR connected to the controller.**

---

**OPTION #25 - ALLOW ZONE 1 THERMOSTAT STAGING** The default setting is **OFF**. Press the **UP** or **DOWN** button to turn **ON**. When this setting is **ON**, the controller will accept a 2nd stage call from the Zone 1 Thermostat. **NOTE: When this option is turned ON, Zone 1 will DISREGARD 2ND STAGE LOCKOUT if Option #21 is turned ON. NOTE: This option will only be available if Option #05 is set for 2-STAGE.** Press the **SETUP** button to proceed to the next option.

---

**OPTION #26—SET 2ND STAGE CUT-IN TIME BASED ON TIME ONLY** The default setting is **OFF**. Push the **UP** or **DOWN** button to turn setting **ON**. Press the **SETUP** button to proceed to the next option.

---

**OPTION #27—SET 2ND STAGE CUT-IN BASED ON TIME AND TEMPERATURE** The default setting is **8 MINS**. Push the **DOWN** button to change the timing to **6 MINS** or **4 MINS**. Press the **SETUP** button to proceed to the next option.

---

**OPTION #28—SET SECOND STAGE CUT-IN TIME (TIME ONLY)** The default setting is **15 MINS**. Push the **UP** button to change to **20 MINS** or the **DOWN** button to change to **10 MINS**. Press the **SETUP** button to exit the setup menu.

---

### DUAL FUEL HEAT PUMP (HYBRID HEAT)

Press the **SETUP** button **TWO TIMES** to enter the configuration mode. The screen will display the **SETUP MENU AND OPTION #03 - SET SYSTEM TYPE**. The default setting is **A/C - GAS ELECTRIC**. Press the **UP** button three times to change the system to **DUAL FUEL HEAT PUMP**. **NOTE: The outdoor FRESH AIR SENSOR MUST be plugged into the controller to configure for DUAL FUEL HEAT PUMP. If the sensor is NOT plugged in, the screen will display INST FA SNSR FOR DFHP. After installing the FRESH AIR SENSOR, press the RESET button to re-enter the configuration mode.** Press the **SETUP** button to proceed to the next option.

---

**OPTION #04 - SET TEMPERATURE DISPLAY** The default setting is **FAHRENHEIT**. Press the **UP** or **DOWN** button to change the setting to **CELCIUS**. Press the **SETUP** button to proceed to the next option.

---

**OPTION #05 - SET OUTDOOR UNIT SPEED** The default setting is **1-SPEED**. If using single stage equipment, press the **SETUP** button to proceed to the next option. If using 2-stage equipment, press the **UP** or **DOWN** button to select **2-SPEED**. Press the **SETUP** button to proceed to the next option.

---

**OPTION #06 - SET THERMOSTAT 1 TYPE** The default setting is **GAS/ELECTRIC**. Press the **UP** or **DOWN** button to change to **HEAT PUMP**. Press the **SETUP** button to **SET THERMOSTAT 2 TYPE**. Repeat for the **Zone 3** and **Zone 4** Thermostats. The default setting is **GAS/ELECTRIC**. Press the **UP** or **DOWN** button to change to **HEAT PUMP**.

**NOTE: A heat pump thermostat with an emergency heat switch MUST be installed on Zone 1 to manually turn on auxiliary heat.** Press the **SETUP** button to proceed to the next option.

---

**OPTION #07 - SET REVERSING VALVE ACTUATION** The default setting is **REV-O**. Press the **UP** or **DOWN** button to change to **REV-B**. **NOTE: When set as REV-O, the reversing valve will energize in COOLING. When set as REV-B, the reversing valve will energize in HEATING.** Press the **SETUP** button to proceed to the next option.

---

## Configuration and Setup

### DUAL FUEL HEAT PUMP (CONTINUED)

**OPTION #09 - SET GAS HI-TEMP CUT-OUT** The default setting is **135° F (60 C)**. Press the **UP** or **DOWN** button to change the temperature. The adjustable range is **125° F to 150° F (57° to 65° C)**. Press the **SETUP** button to proceed to the next option.

---

**OPTION #10 - SET LO-TEMP CUTOUT** The default setting is **44° F (7° C)**. Press the **UP** or **DOWN** button to change the temperature. The adjustable range is **40° F to 52° F (4° to 11° C)**. Press the **SETUP** button to proceed to the next option.

---

**OPTION #11 - SET HEAT PUMP HI-TEMP CUTOUT** The default setting is **120° F (48° C)**. Press the **UP** or **DOWN** button to change the setting. The adjustable range is **110° F - 125° F (43° to 52° C)**. Press the **SETUP** button to proceed to the next option.

---

**NOTE: If Option #05 is set for 1-STAGE, the next option will be OPTION #12.**

**If Option #05 is set for 2-STAGE, the next option will be OPTION #14.**

---

**OPTION #12 - SET AUX HEAT CUT-IN TEMP** The default is **90° F (32° C)**. Press the **UP** or **DOWN** button to change the setting. The adjustable range is **90° - 100° F (32° to 37° C)**. Press the **SETUP** button to proceed to the next option.

---

**NOTE: This option only available on 1-STAGE systems.**

---

**OPTION #13 - SET AUX HEAT CUTIN TIME** The default is **6 Mins**. Press the **UP** or **DOWN** button to change the setting. The adjustable range is **3 - 6 MINS, 10 MINS, 15 MINS or 20 MINS**. Press the **SETUP** button to proceed to the next step.

---

**NOTE: This option only available on 1-STAGE systems.**

---

**OPTION #14 - SET ECONOMIZER MODE** The default setting is **OFF**. Press the **UP** or **DOWN** button to turn **ON**. Press the **SETUP** button to proceed to the next option.

**NOTE: If economizer mode is OFF, the next option is OPTION #16.**

**If economizer mode is ON, the next option is OPTION #15.**

---

**OPTION #14 - SET ECONOMIZER MODE** The default setting is **OFF**. Press the **UP** or **DOWN** button to turn **ON**. Press the **SETUP** button to proceed to the next option.

**NOTE: If economizer mode is OFF, the next option is OPTION #16.**

**If economizer mode is ON, the next option is OPTION #15.**

---

**OPTION #15 - SET ECONOMIZER OUTSIDE SETPOINT** - The default setting is **55° F (12° C)**. Press the **UP** or **DOWN** button to change the temperature. The adjustable range is **50° F to 75° F (10° to 24° C)**. Press the **SETUP** button to proceed to the next option.

---

**OPTION #16 - SET FRESH AIR MIN/HR** The factory default is **0** minutes. Press the **UP** button to add fresh air minutes. The adjustable range is **0 to 60** minutes per hour, adjustable in **5 minute** increments. **NOTE: THIS OPTION IS ONLY AVAILABLE IF OPTION #14 (ECONOMIZER) IS TURNED OFF.** Press the **SETUP** button to proceed to the next option.

---

**NOTE: If fresh air minutes are GREATER than ZERO (0) then the next option will be OPTION #17.**

**If fresh air minutes are set at ZERO (0), and the Equipment Stage is set for 1-Stage, then the next option will be OPTION #22.**

**If the Equipment Stage is set for 2-Stage, the next option will be OPTION #21**

---

## Configuration and Setup

### DUAL FUEL HEAT PUMP (CONTINUED)

**OPTION #17 - SET FRESH AIR SENSOR MODE** The factory default is **OFF**. Press the **UP** or **DOWN** button to turn the sensor **ON**. (**NOTE:** If there is no sensor detected plugged into the FA SNS receptacle on the controller, the controller will display **INSTALL FA SENSOR**). After the sensor is plugged in, press the **RESET** button to clear the error message. Press the **SETUP** button several times until **OPTION #17** appears on the display. Press the **SETUP** button to turn the sensor **ON**.

**NOTE: If the fresh air sensor mode is set to ON, then the next option will be OPTION #18.**

**If the fresh air sensor mode is set to OFF, and the Equipment Stage is set for 1-Stage, then the next option will be OPTION #22.**

**If the Equipment Stage is set for 2-Stage, then the next option will be OPTION #21.**

Press the **SETUP** button to proceed to the next option.

---

**OPTION #18 - SET FRESH AIR LO-TEMP LOCKOUT** The factory default is **20° F (-6° C)**. Press the **UP** or **DOWN** button to change the temperature. The adjustable range is **20° F to 40° F (-6° to 4° C)**. Press the **SETUP** button to proceed to the next option.

---

**OPTION #19 - SET FRESH AIR HI-TEMP LOCKOUT** The factory default is **80° F (26° C)**. Press the **UP** or **DOWN** button to change the temperature. The adjustable range is **60° to 100° F (15° to 37° C)**. Press the **SETUP** button to proceed to the next option.

**NOTE: If the Equipment Stage is set for 1-Stage, the next option will be OPTION #22.**

**If the Equipment Stage is set for 2-Stage, the next option will be OPTION #21.**

---

**OPTION #20 - SET DUAL FUEL HP OUTDOOR LO-TEMP LOCKOUT** The factory default is **30° F (-1° C)**. Press the **UP** or **DOWN** button to change. The adjustable range is **20° - 45° F (-6° - 7° C)**. Press the **SETUP** button to proceed to the next option.

**NOTE: The controller will display F/A and the outdoor temperature**

---

**OPTION #21 - SET SECOND STAGE LOCKOUT** The factory default is **OFF**. Press the **UP** or **DOWN** button to turn **ON**. When this option is turned **ON**, the controller **WILL NOT ENERGIZE 2ND STAGE** if only **ONE ZONE** is calling.

Press the **SETUP** button to proceed to the next option.

**NOTE: This option will only appear if Option #05 is set for 2-STAGE equipment.**

---

**OPTION #22 - SET ZONE 1 PRIORITY** The factory default is **OFF**. Press the **UP** or **DOWN** button to turn **ON**. When this option is turned on, any call from the **ZONE 1 THERMOSTAT** will override any call from the **ZONE 2, 3 or 4 THERMOSTAT**. If a call exists on any thermostat other than the **ZONE 1 THERMOSTAT**, and an opposing call is made from the **ZONE 1 THERMOSTAT**, the system will immediately to into a **3-minute PURGE** and then will turn on the equipment based on the call from the **ZONE 1 THERMOSTAT**.

---

**OPTION #23 - SET AUTO CHANGEOVER TIME** The factory default is **10 minutes**. Press the up or down button to change the setting to **15 MINUTES**. This setting determines the amount of time that elapses after an opposing call occurs and the system changes over to the opposing call. Press the **SETUP** button to proceed to the next option.

---

**OPTION #24 - DISABLE AUX HEAT STAGING ABOVE 40 DEG** The default setting is **OFF**. Press the **UP** or **DOWN** button to turn **ON**. When this feature is turned **ON**, the controller **WILL NOT** stage on Auxiliary Heat if the **OUTDOOR TEMPERATURE** is above **40° F (4° C)**.

**NOTE: This option REQUIRES the use of a FRESH AIR SENSOR connected to the controller.**

---

**OPTION #25 - ALLOW ZONE 1 THERMOSTAT STAGING** The default setting is **OFF**. Press the **UP** or **DOWN** button to turn **ON**. When this setting is **ON**, the controller will accept a 2nd stage call from the Zone 1 Thermostat. **NOTE: When this option is turned ON, Zone 1 will DISREGARD 2ND STAGE LOCKOUT if Option #21 is turned ON. NOTE: This option will only be available if Option #05 is set for 2-STAGE.** Press the **SETUP** button to proceed to the next option.

---



## Configuration and Setup

### DUAL FUEL HEAT PUMP (CONTINUED)

**OPTION #26—SET 2ND STAGE CUT-IN TIME BASED ON TIME ONLY** The default setting is **OFF**. Push the **UP** or **DOWN** button to turn setting **ON**. Press the **SETUP** button to proceed to the next option.

**OPTION #27—SET 2ND STAGE CUT-IN BASED ON TIME AND TEMPERATURE** The default setting is **8 MINS**. Push the **DOWN** button to change the timing to **6 MINS** or **4 MINS**. Press the **SETUP** button to proceed to the next option.

**OPTION #28—SET SECOND STAGE CUT-IN TIME (TIME ONLY)** The default setting is **15 MINS**. Push the **UP** button to change to **20 MINS** or the **DOWN** button to change to **10 MINS**. Press the **SETUP** button to exit the setup menu.

## SEQUENCE OF OPERATION

### SINGLE STAGE COOLING (A/C AND HEAT PUMP)

On any cooling call from one of the thermostats, the controller will energize the **Y1** and **G** outputs to the equipment. The damper for the zone calling will remain open, and the damper for the zone NOT calling will close. During this call, if the other zone makes a cooling call, the zone damper will open. When a thermostat becomes satisfied, and if a call exists from the other thermostat, the damper on the satisfied zone will close. Once the other thermostat becomes satisfied, the controller will de-energize the **Y1** and **G** outputs to the equipment, and both dampers will open. (system idle)

### LOW TEMP CUTOUT

During a cooling call, if the Supply Air Temperature falls BELOW the LOW TEMP CUTOUT temperature, the controller will de-energize the **Y1** output to the equipment and will leave the **G** output energized. A 3-minute DELAY TIMER will be displayed. After the 3-minute delay, if the Supply Air Temperature has risen ABOVE the LOW TEMP CUTOUT temperature, the controller will re-energize the **Y1** output to the equipment.

### TWO STAGE COOLING (A/C AND HEAT PUMP)

The EZ2F Controller utilizes built in intelligent SmartStaging. This allows the use of single stage thermostats on both zones. The controller will energize and de-energize second stage based on elapsed run time and the supply air temperature, or elapsed time only. If set up for time and temperature, on an initial call for cooling, the controller will energize the **Y1** and **G** outputs to the equipment. After an initial run time of 8 MINUTES, (adjustable to 6 mins or 4 mins) if the supply air temperature has not fallen to at least **10 DEGREES F (6 DEGREES C)** above the low temp cutout, the controller will energize **Y2** to the equipment. **Y2** will stay energized until the supply air temperature falls below **4 DEGREES F (1 DEGREE C)** above the low temp cutout. The controller will then turn off **Y2**. This cycle will continue as the supply air temperature rises and falls. If set up for time only, the controller will energize **Y2** after an initial run time of **20 mins, 15 mins or 10 mins**.

**NOTE: EXAMPLE BASED ON FACTORY DEFAULT SETTINGS**

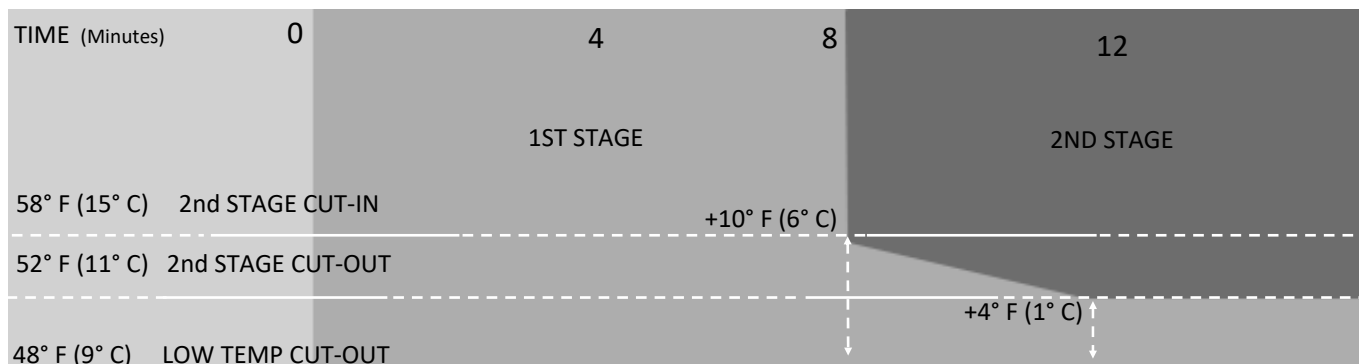

Adjustable Range 40° - 52° F (5° - 11° C)

## SEQUENCE OF OPERATION

### SINGLE STAGE HEATING (GAS & ELECTRIC HEAT / NOT HEATPUMP)

On any heating call from one of the thermostats, the controller will energize the **W1** output to the equipment. After 90 SECONDS of initial run time, the controller will energize the **G** output to the equipment. If the supply air temperature rises above the HI TEMP CUTOUT setting, the controller will de-energize the **W1** output to the equipment. After a 3-minute time delay, if a call still exists and the supply air temperature has fallen below the HI TEMP CUTOUT, the controller will re-energize the **W1** output to the equipment.

### TWO STAGE HEATING (GAS & ELECTRIC HEAT / NOT HEATPUMP)

On any heating call from one of the thermostats, the controller will energize the **W1** output to the equipment. After 90 SECONDS of initial run time, the controller will energize the **G** output to the equipment. After 8 MINUTES of initial run time, if the supply air temperature has not risen to at least **25°F** BELOW the HI TEMP CUTOUT, the controller will energize **W2** to the equipment. The system will run in second stage heating until the supply air temperature rises to **10°F** below the HI TEMP CUTOUT. The controller will then de-energize **W2**. If the supply air temperature falls to **25°F** below the HI TEMP CUTOUT, the controller will re-energize **W2**. This staging will continue until the thermostat is satisfied and the controller turns off the equipment.

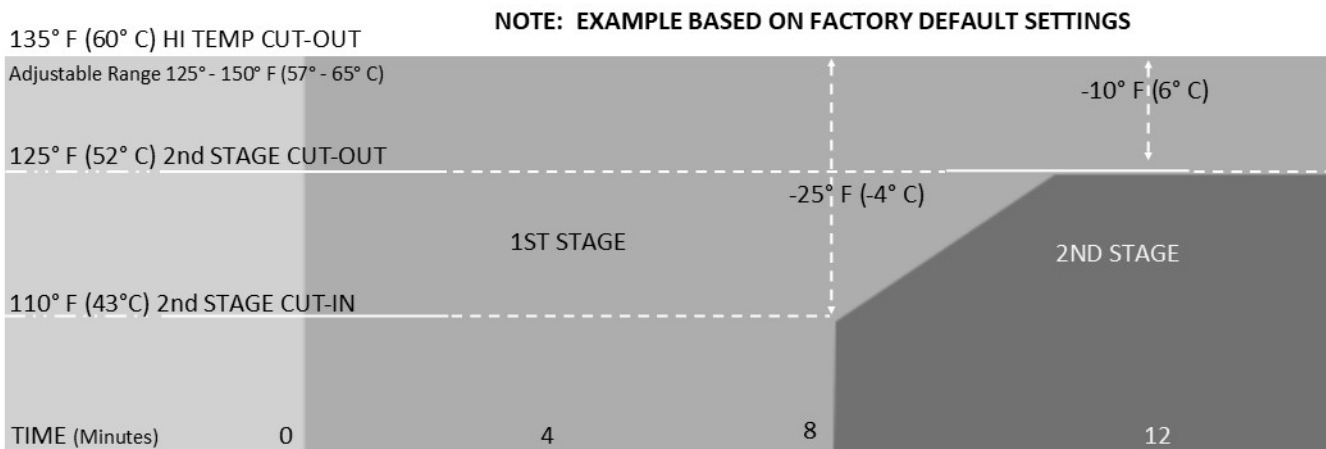

# SEQUENCE OF OPERATION

## SINGLE STAGE HEATING - HEATPUMP

On any heating call from one of the thermostats (**Y** if using heat pump thermostats, **W** if using gas/electric thermostats) the controller will energize the **Y1** and **G** outputs to the equipment. A 3-minute minimum run timer will be displayed. After **6 MINUTES** of initial run time (Factory default. Adjustable 3-6 minutes) if the supply air temperature has not reached **90° F (32° C)** (Factory default. Adjustable **90-100° F [32° - 37° C]**) the controller will energize the **W1** output to the equipment (Auxiliary Heat). The equipment will continue to run in AUXILIARY HEAT until the supply air temperature rises to **10° F** above the AUXILIARY HEAT CUT-IN TEMPERATURE. (Adjusts with Aux. Heat Cut-In Setting). The controller will continue to stage auxiliary heat on and off based on supply air temperature. If the supply air temperature rises above the HI TEMP CUT-OUT temperature, the controller will de-energize the **Y1** output to the equipment and leave the **G** output energized. A 3-minute compressor delay timer will be displayed. After 3 minutes, if the supply air temperature has fallen below the HI TEMP CUT-OUT temperature, the controller will re-energize the **Y1** output to the equipment. See staging chart below.

## TWO STAGE HEATING - HEATPUMP

On any heating call from one of the thermostats (**Y** if using heatpump thermostats, **W** if using gas/electric thermostats) the controller will energize the **Y1** and **G** outputs to the equipment. After 4 minutes of initial run time, if the supply air temperature has not reached **105°F (41°c)** (15°F below the HIGH TEMP CUTOOUT) , the controller will energize **Y2** to the equipment. **Y2** will remain energized until the supply air temperature reaches **115°F (46°C)** (5 degrees below the HIGH TEMP CUTOOUT). The controller will then de-energize **Y2**. The controller will continue to stage Y2 on and off based on the supply air temperature. After 6 MINUTES of initial run time, if the supply air has not reached at least **90°F (32°C)**, the controller will energize **W1** to turn on auxiliary heat. **W1** will remain energized until the supply air temperature reaches **100°F (38°C)** (20°F below the HIGH TEMP CUTOOUT). See staging chart below. **NOTE: AUX HEAT TIME AND TEMPERATURE STAGING IS NOT MANUALLY ADJUSTABLE ON TWO-SPEED HEAT PUMP EQUIPMENT. THE SECOND STAGE AND AUX HEAT STAGING TEMPERATURES MOVE UP AND DOWN BASED ON THE HIGH TEMP CUTOOUT SETTING.**

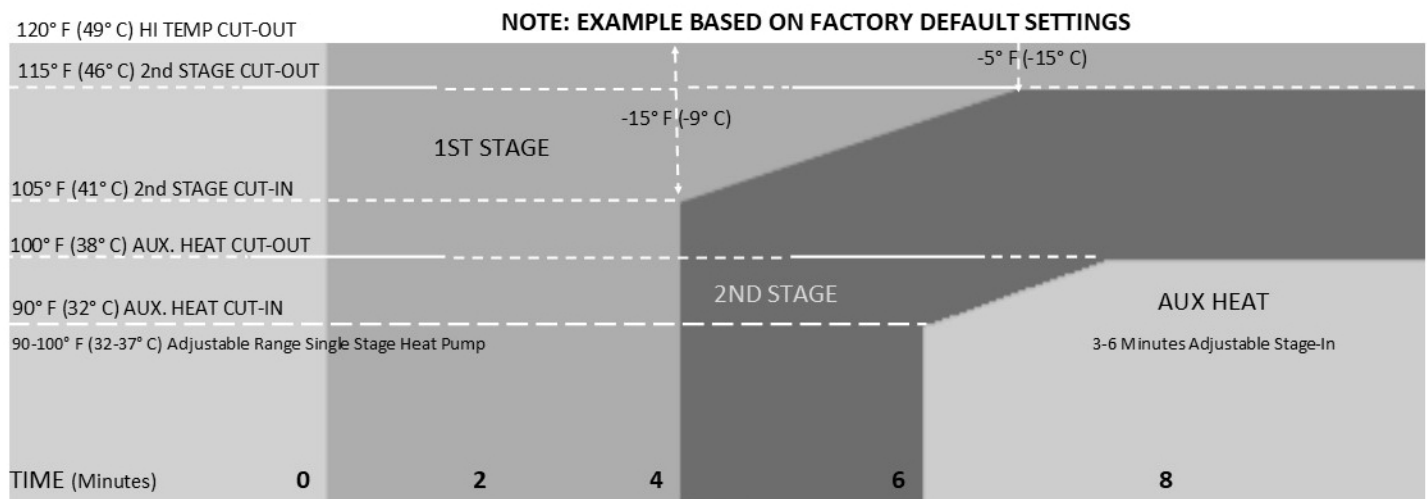

# SEQUENCE OF OPERATION

## DUAL FUEL HEAT PUMP

### SINGLE STAGE AND 2-STAGE COOLING

Single Stage and 2-Stage cooling operates the same on all system types. **REFER TO PAGE 16.**

### SINGLE STAGE HEATING (DUAL FUEL HEAT PUMP)

On any heating call from one of the thermostats (**Y** if using heat pump thermostats [**B** with **Y** if Option #07 is set to **B**], **W** if using gas/electric thermostats) the controller will energize the **Y1** and **G** [and **B** is Option #07 is set to **B**] outputs to the equipment. A 3-minute minimum run timer will be displayed. After 6 MINUTES of initial run time (Factory default. Adjustable 3-6 minutes, 10, 15 or 20 minutes) if the supply air temperature has not reached **90° F (32° C)** (Factory default. Adjustable 90-100°F [32-37°C]) the controller will de-energize the **Y1** output to the equipment and energize the **W1** output to the equipment (Auxiliary Heat). The equipment will continue to run in AUXILIARY HEAT until the thermostat(s) calling is satisfied. If the supply air temperature rises ABOVE the HIGH TEMP CUTOUT, the controller will turn off **W1** to the equipment. The fan will continue to run. After a 3-minute delay, if a call still exists and the supply air temperature has fallen BELOW the high temp cutout, the controller will re-energize **W1** to the equipment. **ONCE THE CONTROLLER HAS SWITCHED TO AUXILIARY HEAT, THE CONTROLLER WILL STAY IN AUXILIARY HEAT UNTIL ALL CALLS ARE SATISFIED.**

### TWO STAGE HEATING (DUAL FUEL HEAT PUMP)

On any heating call from one of the thermostats (**Y** if using heat pump thermostats [**B** with **Y** if Option #07 is set to **B**], **W** if using gas/electric thermostats) the controller will energize the **Y1** and **G** [and **B** is Option #07 is set to **B**] outputs to the equipment. After 4 minutes of initial run time, if the supply air temperature has not reached **105° (41°C)** (15°F [-9°C] degrees below the HIGH TEMP CUTOUT), the controller will energize **Y2** to the equipment. **Y2** will remain energized until the supply air temperature reaches **115°F (46°C)** (5°F [-15°C] below the HIGH TEMP CUTOUT). The controller will then de-energize **Y2**. The controller will continue to stage Y2 on and off based on the supply air temperature. After 6 MINUTES of initial run time, if the supply air has not reached at least **90°F (32°C)**, the controller will de-energize **Y1** and **Y2** and energize **W1** to turn on auxiliary heat. **W1** will remain energized until the thermostat(s) calling is satisfied. If the supply air temperature rises ABOVE the HIGH TEMP GAS CUTOUT, the controller will turn off **W1** to the equipment. The fan will continue to run. After a 3-minute delay, if a call still exists and the supply air temperature has fallen BELOW the high temp cutout, the controller will re-energize **W1** to the equipment. **ONCE THE CONTROLLER HAS SWITCHED TO AUXILIARY HEAT, THE CONTROLLER WILL STAY IN AUXILIARY HEAT UNTIL ALL CALLS ARE SATISFIED.**

**NOTE: AUX HEAT TIME AND TEMPERATURE STAGING IS NOT MANUALLY ADJUSTABLE ON TWO-SPEED HEAT PUMP EQUIPMENT. THE SECOND STAGE AND AUX HEAT STAGING TEMPERATURES MOVE UP AND DOWN BASED ON THE HIGH TEMP CUTOUT SETTING.**

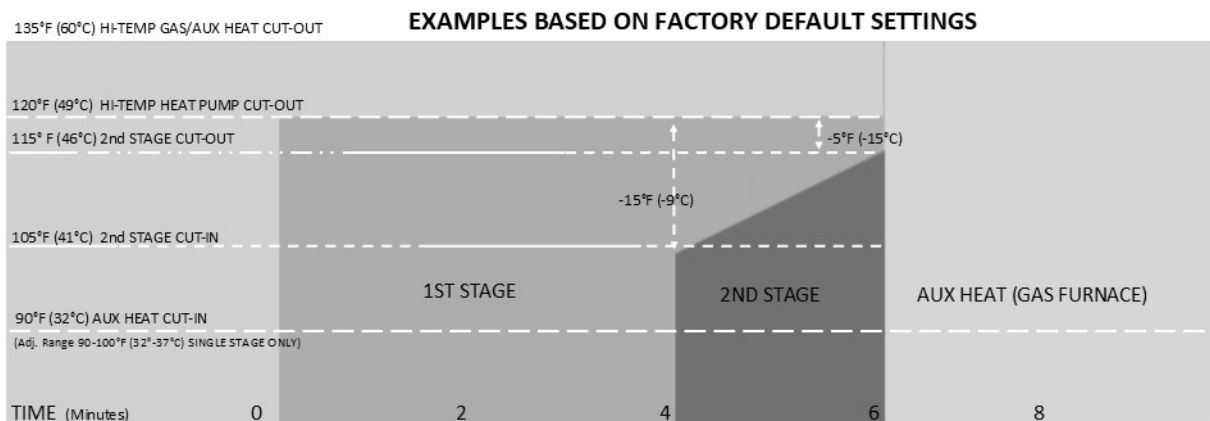

## TOTALINE FEATURES

### EXCLUSIVE EQUIPMENT TEST MODE

The EZ2F Controller can be put into an EQUIPMENT TEST MODE by powering the controller. After the IDLE screen appears, hold down the RESET BUTTON, then hold down the SETUP BUTTON, release the RESET BUTTON and then release the SETUP BUTTON. The controller will display TEST - IDLE -EC. The controller will now only accept calls from the ZONE 1 thermostat, and will not operate the dampers. This allows the installer to set the bypass damper, check the refrigerant charge on the system and verify proper airflow thru the system. After all testing is complete, press and release the RESET button. The controller will reset and go into IDLE mode awaiting calls.

---

### EMERGENCY HEAT - HEAT PUMP AND DUAL FUEL

Emergency heat can **ONLY** be initiated by a HEAT PUMP THERMOSTAT connected to the ZONE 1 thermostat input. A HEAT PUMP THERMOSTAT SHOULD **ALWAYS** be used for the ZONE 1 thermostat in heat pump applications. If the ZONE 1 thermostat calls for EMERGENCY HEAT, the controller will be **LOCKED** into emergency heat (AUX HEAT). **ANY** call for heat from either zone will turn on auxiliary heat. The controller can be **UNLOCKED** by making a call for compressor (heat or cool) from the Zone 1 thermostat.

---

### AUTO CHANGEOVER

It is possible to have one zone calling for cooling and the other zone calling for heating (opposing calls). When an opposing call occurs, a CHANGEOVER TIMER (10 or 15 minutes - Adjustable) will display on the screen. After the timer has reached zero, the system will go into PURGE MODE for **3-MINUTES**. (See PURGE mode below). At the end of the 3-minute purge, the system will switch over to the other mode. If an opposing call still exists, the CHANGEOVER TIMER will restart.

---

### PURGE

Purge occurs whenever the system is running with only one zone calling, and the other zone makes an opposing call. After the changeover time has elapsed the controller turns off the equipment and leaves the fan (**G**) energized. The last zone calling will remain open during the **3 MINUTE** purge (countdown timer displayed on screen). This allows the temperature in the ductwork to equalize before starting the opposing call.

---

### MINIMUM RUN TIME - COMPRESSOR

The EZ2F Controller features a MINIMUM RUN TIME anytime **Y1** is energized to the equipment. This protects the compressor from damage caused by short-cycling.

---

### TIME DELAY

The EZ2F Controller features a TIME DELAY MODE that is designed to protect the compressor from short cycling. The time delay is initiated each time the compressor is de-energized. A 3-MINUTE DELAY timer will be displayed on the screen during this time. The compressor **CANNOT** be restarted until the timer has counted down to zero. In addition, if using a GAS FURNACE and the supply air temperature rises ABOVE the high temp limit, the controller will de-energize **W1** and keep **G** energized. A 3-MINUTE DELAY timer will be displayed on the screen during this time.

---

### ECONOMY MODE

The ECONOMY MODE (**EC**) input on the ZONE 1 TSTAT connector allows the use of a switch, occupancy sensor or dry contact to apply 24 VAC input to the **EC** terminal to put the controller into ECONOMY MODE. This prevents ZONE 2 from making equipment calls. ZONE 2 will only be able to open and close the damper. Only ZONE 1 will be able to make equipment calls.

---

### RH/RC JUMPER

The RH/RC Jumper is factory installed on the TL-EZ4F Controller. If the equipment requires separate transformers for heating and cooling, REMOVE the jumper [JP1] located next to the "**C**" equipment connector. **NOTE: The jumper should NOT be removed for heat pump systems.**

---

### FRESH AIR CONTROL - OPTION#16

The EZ2F Controller features on board Fresh Air Control. A 2-wire or 3-wire damper may be used. The timer is adjustable from **5** to **60** minutes per hour in **5** minute increments. The controller will open the fresh air damper anytime the controller energizes the **G** terminal to the equipment as long as minutes per hour remain. At the end of the hour, if run time minutes still exist (displayed on screen), the controller will turn on the **G** terminal to the equipment, open the fresh air damper, leave the zone dampers open and run until the remaining minutes have elapsed.

---

### EXCLUSIVE FRESH AIR SENSOR MODE - OPTION #17

An outdoor Fresh Air Sensor may be plugged into the controller. By turning on Option #17, a LOW (Option #18) and HIGH (Option #19) temperature limit for fresh air can be set. The low temp setting has a factory default setting of **20° F (-6° C)** and an adjustable range of **20° - 40° F (-6° - 4° C)**. The high-temp setting has a factory default setting of **80° F (26° C)** and an adjustable range of **60° - 80° F (15° - 37° C)**.

**EZ2F FEATURES**

**EXPANSION MODE - EXPANSION - OPTION #01**

The EZ2F Controller can be used as a 4-zone expansion module for larger systems. Option #01 allows the controller to be set as an expansion module. The zoning system can be expanded with up to 9 expansion modules, with a total capacity of 40 zones. Each EXPANSION module requires an individual address (1-9) to be entered at Option #02. Communication is accomplished by use of a SmartLink Cable plugged into the 3-pole Smart Link receptacle at the bottom of each board. For systems with more than 1 expansion module, the communication cables are daisy-chained.

**THERMOSTAT TYPE - OPTION #06**

When using Heat Pump Equipment, the controller allows the use of either Single-Stage Gas/Electric OR Single-Stage Heat Pump thermostats. When electric heat pump or dual fuel system is selected as the System Type (Option #03) the controller will prompt to select what type of thermostat is being used. Calls from gas/ electric thermostats are recognized by the controller and the appropriate equipment terminals are energized. **NOTE: A heat pump thermostat with an emergency heat switch is REQUIRED on Zone 1 in order to turn on EMERGENCY HEAT if needed. Once emergency heat has been initiated, the controller is "LATCHED" into emergency heat. All calls from ALL thermostat will turn on emergency (auxiliary) heat. The controller can only be "UNLATCHED" by making a compressor call (Y in either heating or cooling). After the board is unlatched, the controller reverts to normal heat pump operation.**

**ECONOMIZER MODE - OPTION #14**

When the Economizer Mode is turned on, the controller will open the economizer and turn on G to the equipment if the outdoor temperature is below the Economizer Outdoor Setpoint (Option #15 - 55° F (12° C) factory default. Adjustable range 50° - 75° F (10° - 24° C). During the cooling call, if the outdoor temperature rises ABOVE the outdoor setpoint, the controller will close the economizer and turn on mechanical cooling.

**DUAL FUEL LOW TEMP LOCKOUT - OPTION #20**

When using Dual Fuel Equipment, a Fresh Air Sensor is REQUIRED for proper operation. Option #20 allows the setting of an Outdoor Lock-out Temperature that will prevent the heat pump from running in extremely low temperatures. The factory default setting is 30° F (-1° C). The adjustable range is 20° - 50° F (-6° -10° C). When the outdoor temperature is BELOW the Lock-Out Temperature setting, the controller will turn on the gas furnace for all heating calls.

**SECOND STAGE LOCKOUT - OPTION #21**

On 2-stage systems, if Option #21 is enabled the controller will not go into second stage with only one zone calling. Both zones MUST be calling for the controller to bring on 2nd stage.

**DISABLE AUX HEAT STAGING - HEAT PUMP AND DUAL FUEL HEATPUMP - OPTION #24**

The EZ2F Controller has the ability disable automatic auxiliary heat staging if the outdoor temperature is above 40° F (5° C).

**ZONE 1 THERMOSTAT STAGING - OPTION #25**

On 2-stage systems, a 2-stage thermostat may be installed and used on Zone 1. When Option #25 is turned ON, the Zone 1 thermostat can initiate 2nd stage heating or cooling after an initial 1 minute minimum run time. This setting also overrides 2nd stage lockout (Option #21) for Zone 1.

**ASHRAE 62.2**

- 1 DETERMINE THE FRESH AIR CFM TO COMPLY WITH ASHRAE 62.2 USING THE TABLE BELOW OR THIS FORMULA:

Floor Area	FRESH AIR CFM				
	BEDROOMS				
	0-1	2-3	4-5	6-7	>7
< 1500	30	45	60	75	90
1501 - 3000	45	60	75	90	105
3001 - 4500	60	75	90	105	120
4501 - 6000	75	90	105	120	135
6001 - 7500	90	105	120	135	150
> 7500	105	120	135	150	165

$$[(\text{TOTAL SQ. FT.}) / 100] + [(\# \text{ OF BEDROOMS} + 1) \times 7.5]$$

- 2 MEASURE THE CFM PROVIDED BY THE FRESH AIR DAMPER WITH AN ANEMOMETER
- 3 CALCULATE FRESH AIR RUN TIME AND SET THIS NUMBER AT OPTION #16

$$\text{FRESH AIR RUN TIME} = 60 \times \frac{\text{FRESH AIR CFM}}{\text{MEASURED - CFM}}$$